

Med4 OOADP (Aalborg University, Aalborg)

Exercises 7

Interpreting class diagrams

David Meredith

Study each of the class diagrams given below and explain what they mean. You may use separate text and/or annotate the diagrams. Make sure you identify and explain the presence of each element in each diagram. Identify any errors and suggest any improvements.

1.

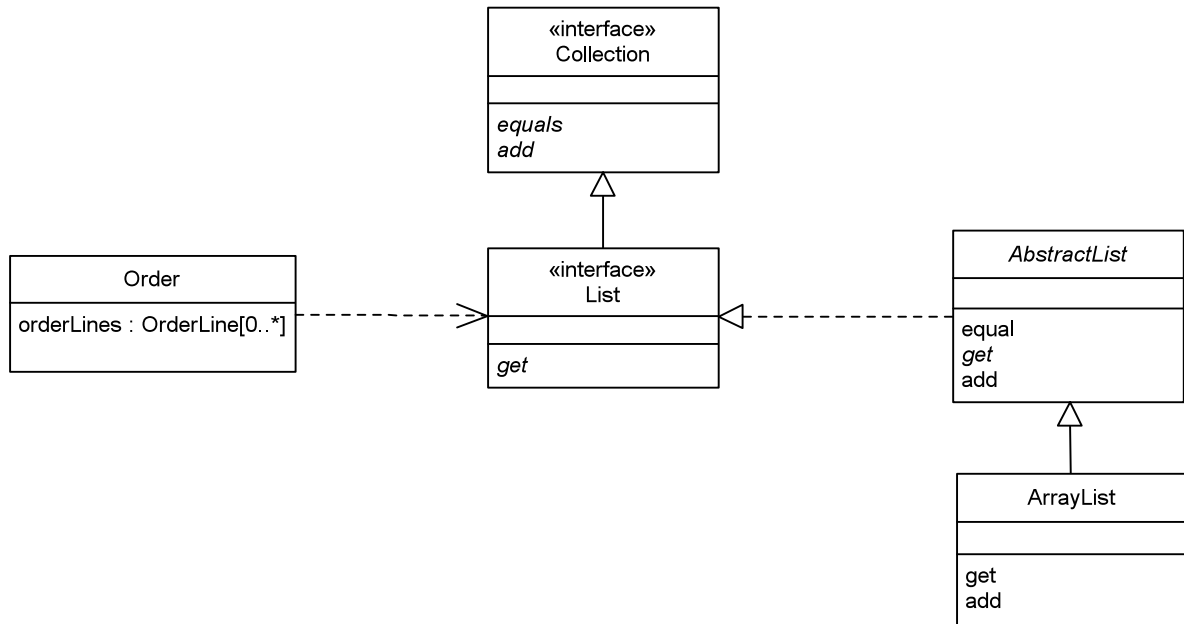

2.

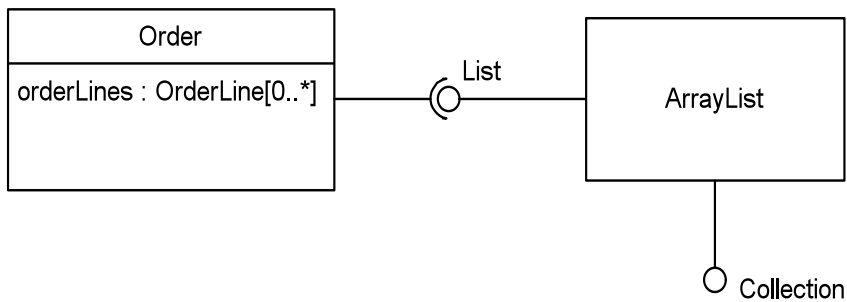

3.



4.



5.

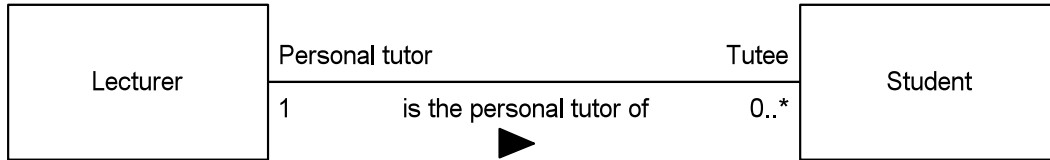

6.

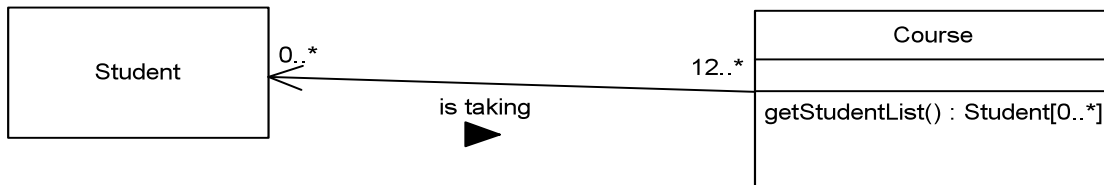

7.

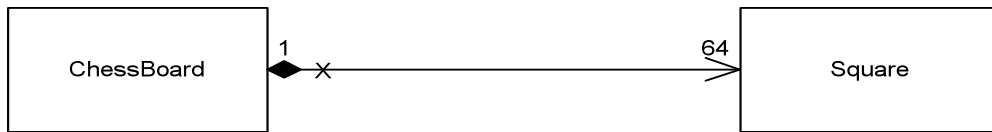

8.

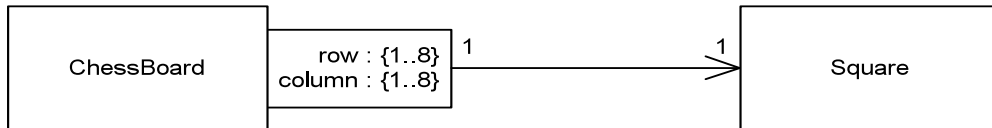

9.

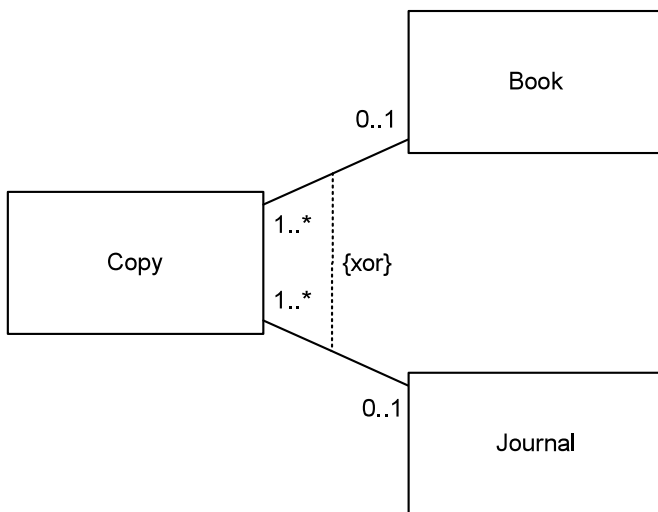

10.

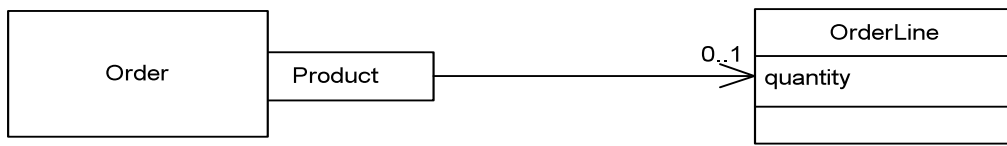

11.

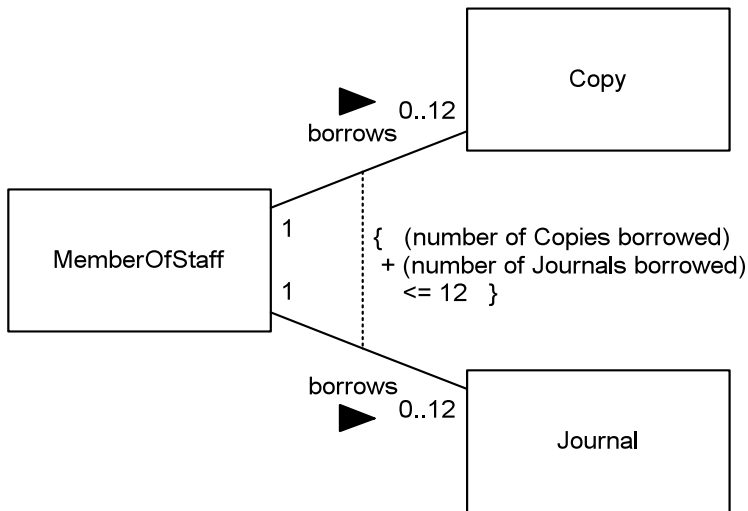

12.

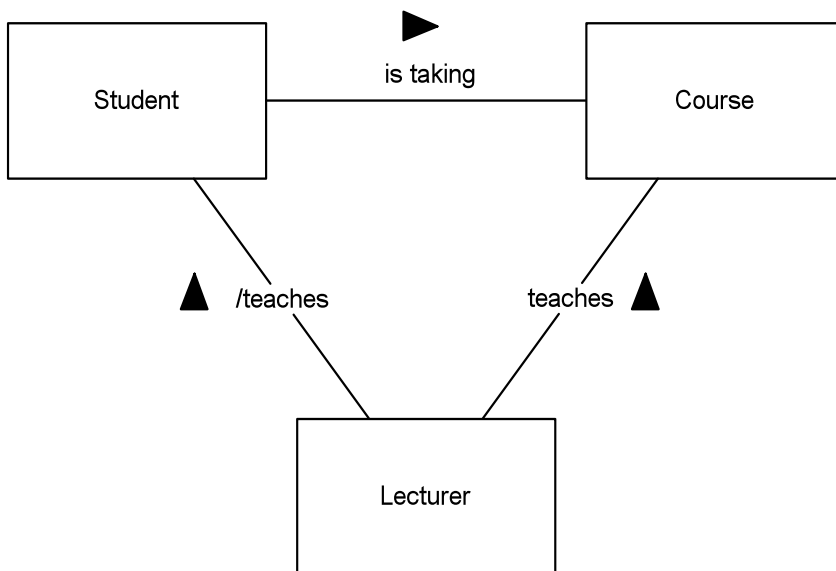

13.

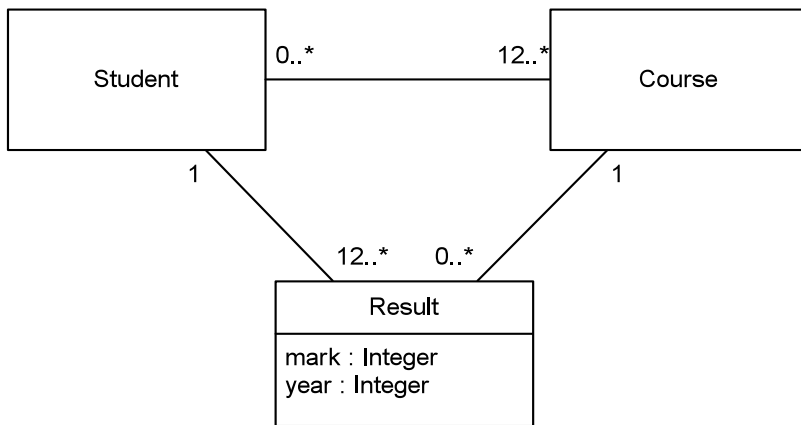

14.

